

- Parts list -

<b>Vehicle</b>	WDDHF5GB5BA389257 (D02)	E 350 Sedan	
<b>Color</b>	775 - BRIGHT SILVER METALLIC CLEAR COAT PAINT	<b>Equipment</b>	108 - IMITATION LEATHER - GRAY
FIN: WDD2120561A389257		<b>Assortment class</b>	PC
<b>Group</b>	83 Heating and ventilation	<b>Sub-group</b>	035 Heating and air conditioner housing with blower and wiring harness

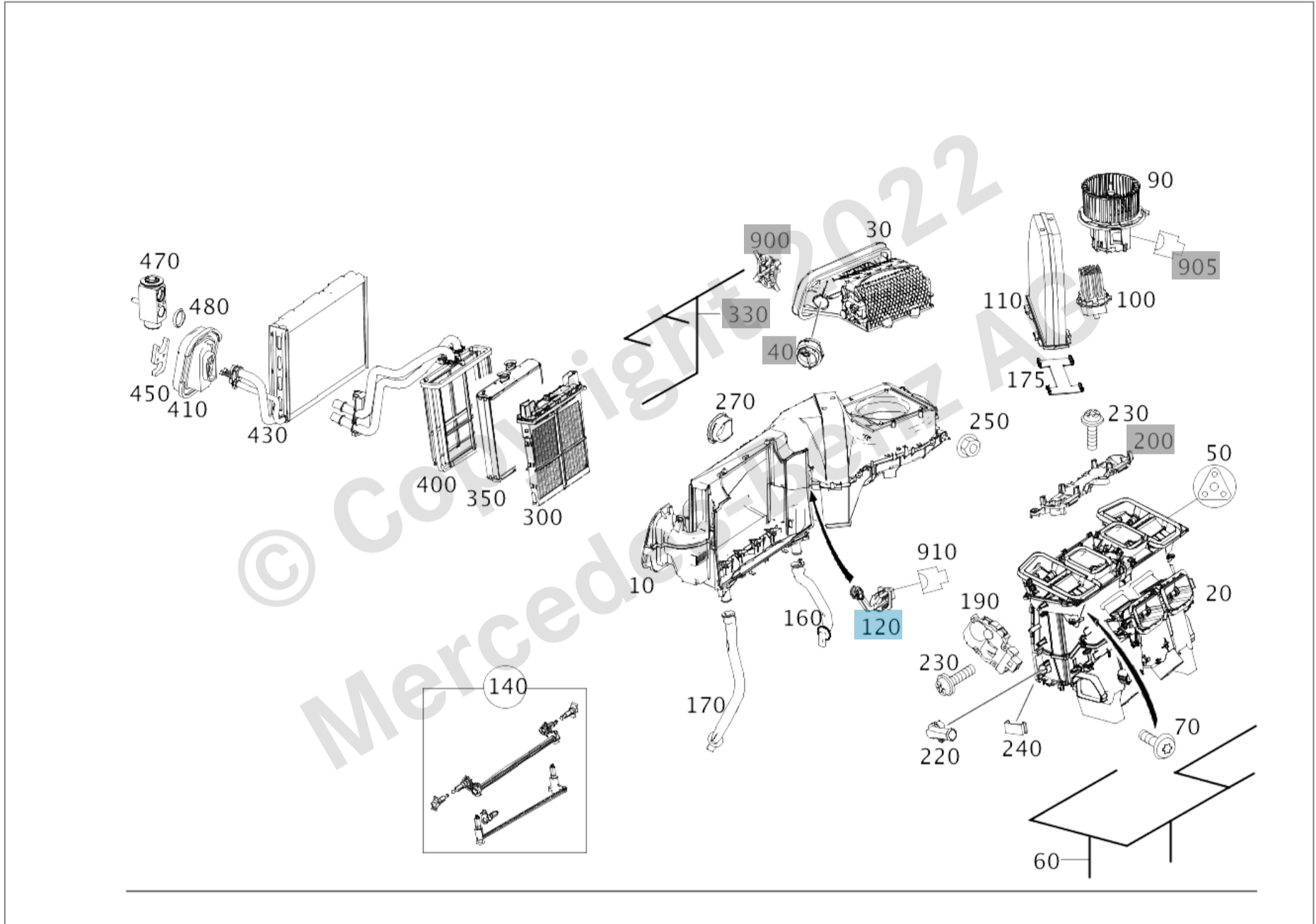































Image ID: drawing\_B83035000044

Item	Part number	Designation/additional information	Qty
10	A 204 830 35 03	PARTS KIT, HOUS., AC BOX UPPER AND LOWER HALVES Code: -800; Determine damage code	1
20	A 212 830 07 03	HOUSING AIR CONDITIONER CASE Code: -581; Determine damage code	1
30	A 204 830 25 03	HOUSING FRESH AIR/CIRCULATING AIR Determine damage code	1
50	A 204 831 00 98	PARTS KIT, SEAL, AIR DUCT Determine damage code	1
60	A 212 820 26 13	ELECTRICAL WIRING HARNESS AIR CONDITIONER CABLE HARNESS Code: -800;	1

Item	Part number	Designation/additional information	Qty
70	N 000000 003242	PAN HEAD SCREW EVAPORATOR HOUSING TO CROSSMEMBER; M5X20	1
90	A 212 820 07 08 	RADIAL BLOWER  Code: -800;  Determine damage code	1
100	A 212 870 21 10	BLOWER REGULATOR  Code: -800;  Determine damage code	1
110	A 212 830 00 18	COMBINATION FILTER WITH COVER  Determine damage code Replaced by: <a href="#">A 212 830 02 18</a> Replaced by: <a href="#">A 212 830 03 18</a>	1
110	A 212 830 02 18	COMBINATION FILTER WITH COVER  Determine damage code Replaced by: <a href="#">A 212 830 03 18</a> Replaces: <a href="#">A 212 830 00 18</a>	1
110	A 212 830 03 18 	ACTIVATED CHARCOAL FILTER WITH COVER  [553] MB GENUINE PART PATENTED IN CZ/DE/ES/FR/GB/IT/JP/PL/SK/TR/US AND ALLERGY-FRIENDLY (ECARF).  Determine damage code Replaces: <a href="#">A 212 830 02 18</a> Replaces: <a href="#">A 212 830 00 18</a>	1
120	A 220 830 07 72	TEMPERATURE SENSOR EVAPORATOR  Determine damage code	1
140	A 204 830 01 33	PARTS KIT, CONTROL LEVER PARTS KIT  Determine damage code	1
160	A 204 830 06 96	HOSE CONDENSED WATER DRAIN,RIGHT  Determine damage code	1
170	A 212 830 15 96	HOUSING CONDENSED WATER DRAIN,LEFT  Determine damage code	1
175	A 212 831 03 00	MOUNTING BRACKET FILTER COVER	1
190	A 221 820 00 42	ELECTRIC MOTOR SERVOMOTOR  Determine damage code Replaced by: <a href="#">A 221 906 69 00</a>	5
190	A 221 906 69 00	STEPPER MOTOR SERVOMOTOR  Determine damage code Replaces: <a href="#">A 221 820 00 42</a>	5
220	A 212 835 00 40	VALVE LEFT	1
230	A 001 984 58 29	HEXALOBULAR BOLT AT AIR CONDITIONER CASE; 4X16	42
240	A 000 835 31 34	TENSION SPRING AT AIR CONDITIONER CASE	44
250	N 910104 006001	NUT-AND-WASHER ASSEMBLY EVAPORATOR HOUSING TO CROSSMEMBER; M6	3

Item	Part number	Designation/additional information	Qty
270	A 221 835 02 93	DAMPENING HEATER CASE TO FIRE WALL	2
300	A 212 834 00 60	AIR CONDITIONER BOX FOR HEATER BOOSTER OPENING  Determine damage code	1
350	A 204 830 00 61	HEAT EXCHANGER  Determine damage code	1
400	A 204 830 15 15 	PARTS KIT, PIPING PARTS KIT	1
410	A 204 835 02 98 	SEAL FIREWALL  Determine damage code	1
430	A 204 830 00 58 	EVAPORATOR  Determine damage code	1
450	A 451 830 00 11	RETAINING PLATE VALVE	1
470	A 212 830 02 84  	VALVE EXPANSION VALVE  Code: 800+050/801/802/803/804/805/806;  Determine damage code	1
480	A 140 997 09 45 	* ROUND-SECT. SEALING RING ON SUCTION SIDE; 17X2 MM	1
480	A 140 997 07 45 	* O-RING ON DELIVERY SIDE; 10.6X2 Replaced by: A 013 997 41 45	1
480	A 013 997 41 45 	* SEALING RING ON DELIVERY SIDE; 10.6X2 MM Replaces: A 140 997 07 45	1
910	A 032 545 19 28	RECEPTACLE HOUSING EVAPORATOR TEMPERATURE SENSOR B10/6; 2-PIN MQS	1